

Adaptive LQR Controller For Networked Control Systems Subjected To Random Communication Delays

Seshadhri Srinivasan¹, Mishiga Vallabhan², Sridhar Ramaswamy², and Ülle Kotta¹

Abstract—Control loops integrated with communication channels for information exchange among system components are called Networked Control Systems (NCSs). Introduction of communication channels induce time-varying communication delays and make the controller design complex. In this paper, an adaptive regulator (AR) that varies its gain depending on the delays in the channel is proposed. The construction of AR is based on the LQR approach. Computation of gains in AR is simplified using the first order approximation that reduces computation delays significantly thereby making the adaptation rule more suitable for higher order systems. The results are illustrated using studies conducted on Modbus over TCP/IP (Transmission Control Protocol/Internet Protocol) communication protocol and a simulation example.

I. INTRODUCTION

Modern trend in control is to employ communication channels for information exchange among system components, and such systems are called *Networked Control Systems* (NCSs). An overview of NCSs together with its applications and advantages can be found in [1]-[5], see also references therein. Communication channels introduce time-varying delays in control loops, leading to performance deterioration and possible instability of the system. Controllers for NCSs should accommodate channel delays in their design for meeting the performance specifications and to guarantee stability. Most of the design methods available in literature on NCSs are focused on construction of stabilizing controllers and do not address the performance specifications, for example tracking error. Adaptive controllers have been successfully employed both in academia and industry for systems with time-varying parameters. The essence of adaptive control is to adapt the controller parameters, based on the time-varying system parameter. Presence of time-varying delays in NCSs naturally suggests to use the methods of adaptive control. But the role of adaptation in NCSs has not been fully explored till now.

Adaptive control of NCSs is a recent research topic and the available adaptive control schemes can be classified into three broad categories as: (i) gain-scheduling based approaches [7], [10], [11], [12], (ii) adaptive control based on either assumption regarding the delays [6] or delay models [8], [13], and (iii) adaptive control rules that employ

parameter identification followed by the controller update step [14], [15], [9]. Most of the available results in adaptive control, except [14], do not consider explicit performance metrics intended from the closed-loop systems. In [14], an adaptive control rule employing a parameter identification followed by an adaptation step has been proposed for tracking the reference signal. The proposed adaptive control rule requires the knowledge of the slot size in the channel which is extremely difficult to predefine. Motivated by this, we propose an alternative adaptive control rule for tracking the reference signal in the presence of delays. Compared to [14], we only use a Gaussian distribution for delays in the channel that can be easily found from experiments.

The goal of this paper is to propose an adaptive controller for NCSs subjected to random communication delays that can assure optimality without introducing significant computation delays. We propose an adaptive controller for NCSs that varies its gains based on the delays in the channel. Our controller is based on the LQR approach. The choice of the cost function guarantees the optimal control inputs and tracking errors. The resulting controller requires matrix multiplications that is further simplified using the first-order approximation of the controller gains. In the above linear approximation a learning parameter is used to improve the accuracy of the approximation. The learning parameter is obtained using off-line simulation. To conclude, our controller is computationally efficient yet guarantees high accuracy in tracking the reference signal. Finally, we use the delay model obtained from studies conducted on Modbus over TCP/IP communication channels in our simulations to illustrate the effectiveness of the proposed approach.

The paper is organized in five sections including the introduction. In section II, we study the NCSs model and formulate the problem. In section III, the proposed adaptive control methodology is discussed. Numerical simulations are shown to illustrate the proposed adaptive controller in section IV. Conclusions and future directions of this investigation are discussed in section V.

II. PROBLEM STATEMENT

Consider the linear time-invariant (LTI) system

$$\dot{x}(t) = Ax(t) + Bu^*(t) \quad (1)$$

with controller

$$u^*(t) = u_k, \quad t \in [kh + \tau_k, (k+1)h + \tau_{k+1}) \quad (2)$$

where $x(t) \in \mathbb{R}^n$, $u^*(t) \in \mathbb{R}^m$, $y(t) \in \mathbb{R}^p$ are the state, input and output vectors respectively and A, B, C are

This work was supported by European Union through European Regional Development Fund and target project SF140018s08

¹ S. Seshadhri and U. Kotta are with the Control Systems Dept., Institute of Cybernetics, Tallinn University of Technology, Tallinn, Estonia, 12617 e-mail: (kotta@cc.ioc.ee)

²Sridhar Ramaswamy and M. Vallabhan are with Industrial Software Systems Division, ABB Global Industries and Services Ltd., Bangalore, India srini@ieee.org

constant matrices with appropriate dimensions. Networks N_1 and N_2 are used to connect sensor and controller output to the controller and plant respectively. Generic NCS with dynamics (1) and (2) is shown in Fig. 1.

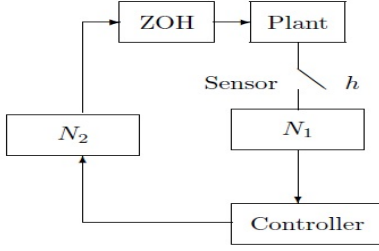

Fig. 1. Networked Control System (NCS)

Total delay in the control input τ_k is the sum of networked-induced delays in the channels N_1 and N_2 , denoted by τ_{sc} and τ_{ca} , respectively and computation delay τ_c in the controller

$$\tau_k = \tau_{sc} + \tau_c + \tau_{ca} \quad k = 0, 1, 2, 3, \dots \quad (3)$$

We assume the total delay in the network τ_k to be less than the sampling period h and, there is no re-ordering of packets. These assumption ensure proper working of the NCSs by eliminating out-of-sequence feedback information. Sampling the system (1) under these assumptions leads to the discrete-time model as in [17], [18]:

$$x_{k+1} = \phi x_k + \Gamma_0(\tau_k)u_k + \Gamma_1(\tau_k)u_{k-1} \quad (4)$$

where $\phi = e^{Ah}$, $\Gamma_0(\tau_k) = \int_0^{h-\tau_k} e^{A\lambda} B d\lambda$ and $\Gamma_1(\tau_k) = \int_{h-\tau_k}^h e^{A\lambda} B d\lambda$.

The problem is to design an adaptive controller that adapts its gains based on the delays τ_k to regulate the state with minimum control effort and/or to meet the desired performance in the presence of time-varying delays. In particular, the controller should

- 1) reduce the deviations of the state x_k from the reference signal r_k with minimum control effort
- 2) reduce the computation delay

The design requirements are conflicting that complicates the controller design. In section III, we design a simple adaptive controller to meet these conflicting design requirements.

III. ADAPTIVE CONTROLLER DESIGN

This section presents LQR based adaptive regulator that adapts its gain in response to the time-varying delays. The resulting control scheme requires complex computation that introduce undesired computation delays. We reduce the complexity using simple approximation.

The control objective is to achieve good regulation with minimum control effort based on the LQR approach, using the cost function

$$J = \sum_{\tau=0}^{N-1} (e_{\tau}^T Q e_{\tau} + u_{\tau}^T R u_{\tau}) + e_N^T Q_N e_N \quad (5)$$

In (5), $e_k = x_k - r_k$, $Q \geq 0$ and $R > 0$ are weighing matrices of appropriate dimensions, and $Q_N \geq 0$ is the terminal weighing matrix.

Define the cost-to-go function at time instant k as,

$$J_k(x_k) = \min_{u_k, \dots, u_{N-1}} \sum_{\tau=k}^{N-1} (e_{\tau}^T Q e_{\tau} + u_{\tau}^T R u_{\tau}) + e_N^T Q_N e_N \quad (6)$$

subject to relations (4).

Note that $J_k(x_k)$ gives the minimum of LQR cost-to-go, starting from the state x_k at time instant k . It has been shown that $J_k(x_k)$ is quadratic, $J_k(x_k) = x_k^T P_k x_k + 2q_k x_k + r_k^T Q r_k$, where $q_k = -Q^T r_k$, $P_k = P_k^T \geq 0$ that can be found recursively working backwards from $k = N$ by taking $P_N = Q_N$.

Now according to the dynamic programming principle, suppose we know $J_{k+1}(x_{k+1})$ and look for optimal u_k . Observe that u_k affects the terms $u_k^T R u_k$ and $J_{k+1}(x_{k+1})$. Therefore,

$$J_k(x_k) = \min_{u_k} [(x_k - r_k)^T Q (x_k - r_k) + u_k^T R u_k + J_{k+1}(x_{k+1})] \quad (7)$$

From the necessary condition for optimality, we obtain, taking into account (4),

$$R u_k + \Gamma_0^T P_{k+1} [\phi x_k + \Gamma_0 u_k + \Gamma_1 u_{k-1}] + \Gamma_0^T P_{k+1} r_k = 0 \quad (8)$$

In the LTI case, as $N \rightarrow \infty$ in (5), the value of P_{k+1} is proved to approach a steady value and can be replaced by a constant matrix $P \geq 0$. It should be noted here that the steady-state solution for P cannot always be guaranteed in the case of time-varying systems, unlike the case of LTI systems. For the simulation example considered in this investigation steady state solution was achieved. This simplification, with little manipulation, leads to

$$u_k = L_x(\tau_k)x_k + L_u(\tau_k)u_{k-1} + L_r(\tau_k)r_k \quad (9)$$

where

$$\begin{aligned} L_x(\tau_k) &= -(R + \Gamma_0^T P \Gamma_0)^{-1} \Gamma_0^T P \phi \\ L_u(\tau_k) &= -(R + \Gamma_0^T P \Gamma_0)^{-1} \Gamma_0^T P \Gamma_1 \\ L_r(\tau_k) &= (R + \Gamma_0^T P \Gamma_0)^{-1} (\Gamma_0^T Q^T) \end{aligned} \quad (10)$$

are the adaptive control gains that depend on the network delay τ_k .

Obviously, the control rule (10) requires the knowledge of the delay τ_k to compute Γ_0 and Γ_1 . Moreover, computational complexity increases as the system order n increases. Below we suggest how to overcome these shortcomings.

A. Modelling Time-Varying Delays

Various models have been proposed for modelling time-varying delays in communication channels [22], [23], [24], [8], [25], [26]. In particular, delays have been described by empirical distributions [22], [23], [24], Markov Chain [25], shifted Rayleigh model [8] and Markov Chain Monte Carlo model [26]. In this paper, like in [21], we assume that the

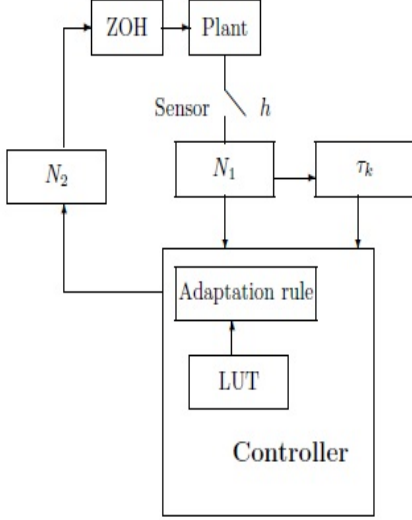

Fig. 2. Schematic Block Diagram of Adaptive Regulator

channel is symmetric (or correlated) meaning that the delays τ_{sc} and τ_{ca} are related by

$$\tau_{sc} = \xi \times \tau_{ca} \quad (11)$$

where ξ is an arbitrary constant determined from experiments. We use measurements from experiment on Modbus over TCP/IP to model the delay. The samples generated by a Gaussian distribution are shown to be close enough to capture the delay distribution and will be used in controller design instead of actual measurements. In case when the empirical distribution does not fit normal distribution well enough, the MH-sampler proposed in [26] can be used for computation of delays.

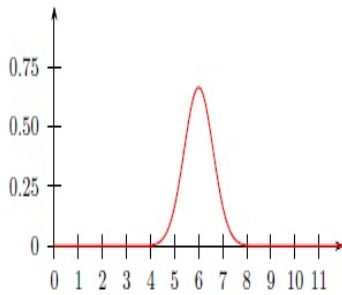

Fig. 3. Gaussian distribution of delays in MODBUS over TCP/IP

B. Approximation of AR Gains

To simplify the computation of controller gains, a look-up-table based approach was used in [26]. Unfortunately, then the controller induces chattering behavior in state and moreover, there are no guidelines to fix the number of

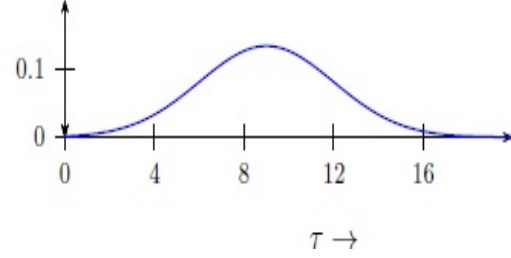

Fig. 4. Gaussian distribution of delays in MODBUS over TCP/IP with network loading

controllers in the table, that in general depends on the delays in the channel.

In this paper, we propose the first order approximation for controller gains

$$L(\tau_k) \approx L(\tau_0) + \frac{\partial L}{\partial \tau}(\tau_k - \tau_0) \quad (12)$$

that will be improved later by introducing a learning parameter $\Psi(\tau)$ that can be computed from off-line simulation, yielding

$$L(\tau_k) \approx \Psi(\tau) L(\tau_0) + \frac{\partial L}{\partial \tau}(\tau_k - \tau_0) \quad (13)$$

Note that in (12) and (13), τ_0 is the nominal delay or the gain, corresponding to the sampling period of the system.

C. Modelling Random Delays in MODBUS over TCP/IP

Experiments conducted on Modbus over TCP/IP were used to model time-varying delays as a Gaussian distribution and the samples generated from this distribution were used for verification of performance of AR. Two sets of experiments were conducted, one without loading the network i.e. without any other i/o (input and outputs) and the other by loading the network (increase in number of i/o's). We employed the ABB's AC-500 controller to model the delay. Fig. 3 and Fig. 4 show the distribution of delays when the channel is not loaded and with loading, respectively.

IV. RESULTS AND DISCUSSIONS

A. Numerical Example

The double integrator system

$$\begin{aligned} \dot{x}(t) &= \begin{bmatrix} 0 & 1 \\ 0 & 0 \end{bmatrix} x(t) + \begin{bmatrix} 0 \\ 1 \end{bmatrix} u(t) \\ y(t) &= \begin{bmatrix} 1 & 0 \end{bmatrix} x(t) \end{aligned} \quad (14)$$

is used to illustrate the effectiveness of the proposed adaptive regulator. Continuous-time dynamics (14) is discretized with sampling period h under the assumption that $\tau_k \leq h$, resulting in

$$x_{k+1} = \begin{bmatrix} 1 & h \\ 0 & 1 \end{bmatrix} x_k + \begin{bmatrix} \frac{(h-\tau)^2}{2} \\ h-\tau \end{bmatrix} u_k + \begin{bmatrix} \tau(h-\frac{\tau}{2}) \\ \tau \end{bmatrix} u_{k-1} \quad (15)$$

The sampled-data representation of linear NCS with total

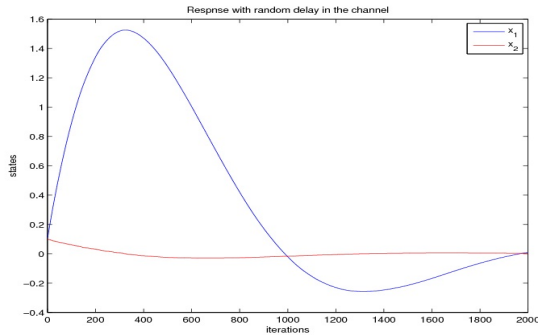

Fig. 5. States of the double integrator system with AR controller and network loading

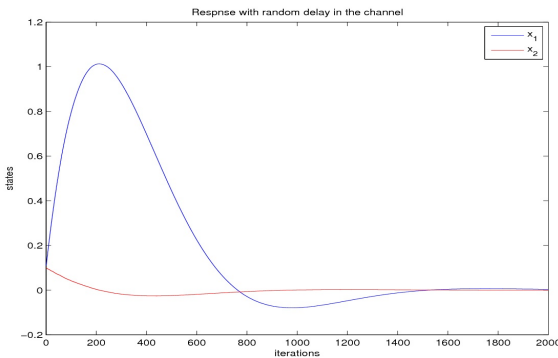

Fig. 6. States of the double integrator system with AR controller and without network loading

delays less than sampling period can be obtained using MATLAB and the routine *NCSsd*, developed by the author of this paper [27]. The effectiveness of the proposed approach is illustrated using both delay measurements (assuming symmetrical channels) and the samples collected from Gaussian distribution with mean and variance computed from the experimentation. States of the system (15) with delay measurements from Modbus over TCP/IP network with loading and AR controller (9) that involves matrix computations (10) are shown in Fig. 5. It can be seen that the states are driven to zero thereby showing the regulatory performance of the AR controller. Simulation performance for 2000 iterations with sampling period of $10ms$ resulted in a computation delay of $2ms$ per computation approximately. Here the computation delay is quite significant and can increase with the order of the system.

Simulation results for AR controller with delay samples generated using the Gaussian distribution shown in Fig.3 (i.e. low load condition) and with the first order approximation in (13) is shown in Fig.6. Simulations were run for 2000 iterations with the system sampling period of $10ms$ resulted in a computation of delay of $0.08ms$ per computation approximately. This is a significant reduction in computation delays. What is equally or even more important, the computation delay is independent of the order of the system since only

the first order approximations are used in the computations of gain. Simulations also indicate that the computation time of the approximation is independent of the nature of delays in the channel. Variations of parameters L_u, L_{x1}, L_{x2} for delays

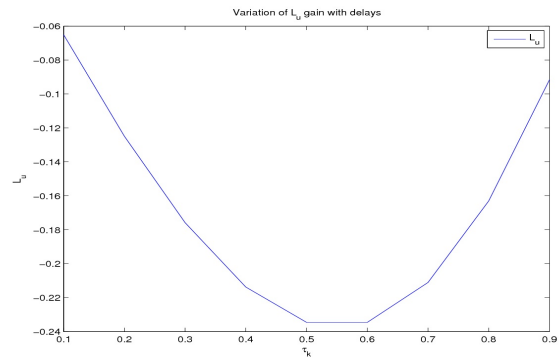

Fig. 7. Variations of the gain L_u with delays

$\tau \leq h$ with sampling period $h = 100ms$ are shown in Fig. 7, 8 and 9, respectively. A sampling period of $1s$ is used to show the variations as for lower values the variations in gain cannot be easily visualized from the graphs.

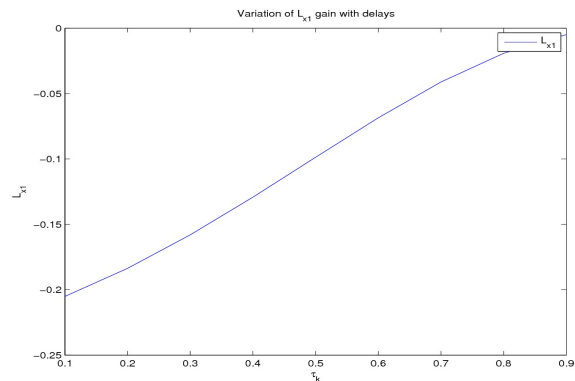

Fig. 8. Variations of the gain L_{x1} with delays

V. CONCLUSIONS

In this investigation an adaptive regulator (AR) for NCSs subjected to random communication delays was proposed. The computations in controller were simplified using the first order approximation and it is confirmed using simulation that the approximation reduces the complexity associated with controller computations significantly. The proposed methodology is illustrated using numerical simulations and experiments conducted on Modbus over TCP/IP protocol. Investigations on stability, implementation on real-time simulation platform like True Time, and handling packet dropouts are future research topics.

ACKNOWLEDGMENT

The authors acknowledge H. Voit, Institute of Automatic Control Engineering, Technische Universität München for his clarifications on his publication in ACC 2011.

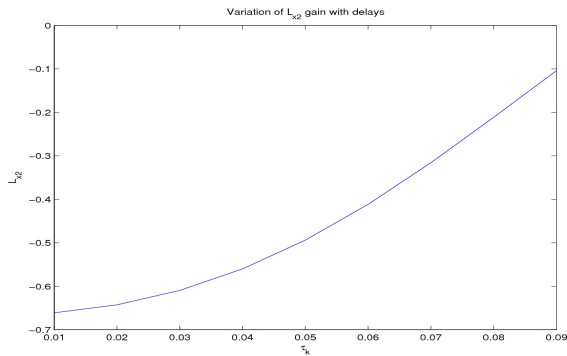

Fig. 9. Variations of the gain L_{x2} with delays

REFERENCES

- [1] J. Baillieul, and P.J. Antsaklis, "Control and Communication challenges in networked real-time control systems", *Proceedings of the IEEE*, vol. 95, no.1, Jan. 2007, pp. 925.
- [2] J. P. Hespanaha, P. Naghshtabrizi, and, Y. Xu, "A survey of recent results in networked control systems", *Proceedings of the IEEE*, vol. 95, no.1, Jan. 2007, pp. 138162.
- [3] T.C. Yang, "Networked Control Systems: A brief survey", *IET control theory and applications*, vol. 153, no.4, 2006, pp. 403412.
- [4] Y. Tipsuwan and M. Y. Chow, "Control methodologies in networked control systems", *Cont. Eng. Pract.*, vol. 11, pp. 1099-1111, 2003.
- [5] S. Seshadhri, Estimation and design methodologies for networked control systems with communication constraints, Ph.D. dissertation, Dept. Instrumentation and Control Eng., National Institute of Technology, Tiruchirappalli., Tiruchirappalli, India, 2010.
- [6] P. Marti, J. Yepez, M. Velasco, R. Villa, and J. Fuertes, "Managing quality-control in networked-based control systems by controller and message scheduling co-design", *IEEE Transaction on Industrial Electronics*, vol. 51, no. 6, pp. 1159-1167, Dec 2004.
- [7] A. Tzes, and G. Nikolakopoulos, "LQR-Output feedback gain scheduling of mobile networked controlled systems", in *Proceedings of the 2004 American Control Conference*, Boston, Massachusetts, 2004, pp. 4325-4329
- [8] N. B. Loden, and J. Y. Hung, "An adaptive PID controller for network based control systems", *IEEE 31st Annual Conference on Industrial Electronics Society, IECON 2005*, 2005, pp. 2445-2450.
- [9] L. Chunmao and X. Jian, "Adaptive delay estimation and control of networked control systems", in *International Symposium on Communication and Information Technologies (ISCIT)*, 2006.
- [10] E.P. Godoy, A. J. V. Porto, and R. Y. Inamasu, "Sampling time adaptive control methodology for CAN-based Networked Control Systems", in *2010 9th IEEE/IAS International Conference on Industry Applications (INDUSCON)*, 2010, pp.1-6.
- [11] S. Plitz, M. Björkbom, L. Eriksson, and H. Koivo, "Step adaptive controller for networked mimo control systems", in *Proc. of International Conference on Networking, Sensing and Control (ICNSC)*, 2010, pp. 464-469.
- [12] M. Björkbom, "Wireless control system simulation and network adaptive control", *PhD dissertation*, School of Science at Technology, Aalto University, Dept. of Automation and Systems Technology, Oct. 2010.
- [13] A. H. Tahou, and F. H-jing, "Adaptive stabilization of networked control systems", *Journal of Applied Sciences*, vol.7, no.22, 2007, pp.3547-3551.
- [14] H. Voit, A. Annaswamy, "Adaptive Control of a Networked Control System with Hierarchical Scheduling", in *American Control Conference 2011*, San Francisco, CA, July 2011, pp. 4189-4194
- [15] A. Annaswamy, D. Goswami, and S. Chakraborty "Tutorial on arbitrated networked control systems approach to cyber-physical systems, CPSWeek, 2011.
- [16] G. Tao, "Adaptive control design and analysis", John Wiley and Sons, Inc. New Jersey, 2003.
- [17] Z. Wei, M. S. Branicky and S. M. Philips, "Stability of networked control systems :explicit analysis of delay, *IEEE Control System Magazine*, vol. 21, no. 1, pp. 84-99, 2001.
- [18] K. J. Åström, and B. Wittenmark, *Computer Controlled Systems: Theory and Design.*, Prentice Hall, 1990.
- [19] J. Daafouz, P. Reidinger, and C. Lung, "Stability analysis and control synthesis for switched system: A Lyapunov function approach", *IEEE Transactions on Automatic Control*, vol. 47, 2002, pp. 1883-1887.
- [20] A. Bemporad, M. Heemels, and M. Johanson *Networked Control Systems*, Springer-Verlag, 2010, pp.203-253.
- [21] M. Vallabhan, S. Seshadhri, S. Ashok, S. Ramaswamy, and R. Ayyagari, "An analytical framework for analysis and design of networked control systems with random delays and packet losses", in *Proceedings of the 25th Canadian Conference on Electrical and Computer Engineering (CCECE)*, 2012, Quebec, Canada.
- [22] A. Mukerjee, On the dynamics and significance of low frequency components of internet load, *Inter networking :research and Experience* , vol. 5, pp. 163-205, 1994.
- [23] H. Chan and U. Ozguner, Closed loop of control systems over communication systems with queues, *Int. Journal of Control*, vol 62, no.3, pp. 493-510.
- [24] Y. Tipsuwan and M. -Y. Chow, "Gain Scheduler middleware: A methodology to enable existing controller for networked control and tele-operation- Part 1: Networked Control *IEEE Transactions on Industrial Electronics*, vol. 51, no.3, pp. 1218-1227, Dec. 2004.
- [25] J. Nilsson *Real Time Control Systems with Time Delays*, PhD Dissertation, Department of Automatic Control, Lind Institute of Technology, Sweden, 1998.
- [26] S. Seshadhri and R. Ayyagari, "Dynamic controllers for networked control systems with random communication delays", *International Journal of Systems, Control, and Communications (IJSCC)-Special issue on progress in Networked Control Systems* , vol. 3, no. 2, April 2011, pp. 178-193.
- [27] S. Seshadhri, Sampled-data model for NCSs with delay less than sampling time", <http://www.mathworks.com/matlabcentral/fileexchange/37875>
- [28] F. Lian, *Analysis , Design, Modelling and Control of Networked Control Systems* , PhD Dissertation, Department of Mechanical Engineering, University of Michigan, Ann Arbor , MI, USA, 2001.

2013 American Control Conference

(ACC 2013)

**Washington, DC, USA
17 - 19 June 2013**

Pages 1-817



**IEEE Catalog Number: CFP13ACC-POD
ISBN: 978-1-4799-0177-7**